

Edition
2024-2025

siccom
INNOVATIVE VISION

CONDENSATE PUMPS

For air conditioners, refrigerated displays and boilers



ENTER A NEW ERA OF SILENCE

AND

DISCOVER NEW PRODUCTS

www.siccom.com

FEW WORDS ABOUT SICCOM

SICCOM S.A.S was founded in 1979 and specialises in condensate removal pumps, level and proximity sensors, bimetal heat protection, and interference suppressors for car industry.

SICCOM's expertise means customers can benefit from a range of high added-value products that meet installers' requirements.

SICCOM technology is designed and implemented by its own engineering department, made up of a number of highly qualified engineers and technicians.

SICCOM constantly strives to innovate and now enjoys worldwide success in more than 50 countries.

As it has grown, it has opened factories in Madagascar, China and Bulgaria, and subsidiaries in Milan, Barcelona and New Delhi alongside its head office in the Paris area.

This international presence means it is able to supply customers regardless of any particular geopolitical situation.

Eco-design

SICCOM makes every effort to support its developments with major ecological improvements. From production to product recyclability, our design office strives to reduce the environmental impact of our products at every stage. The new DT range of pumps is proof of this, being the perfect combination of market expectations, environmentally-friendly production and easy recycling.

Our approach:
«Significant environmental improvements,
better service for our customers.»

Certifications

All our sites have received ISO 9001 certification.

Quality procedures encompass all of the company's services, ensuring optimal quality levels.

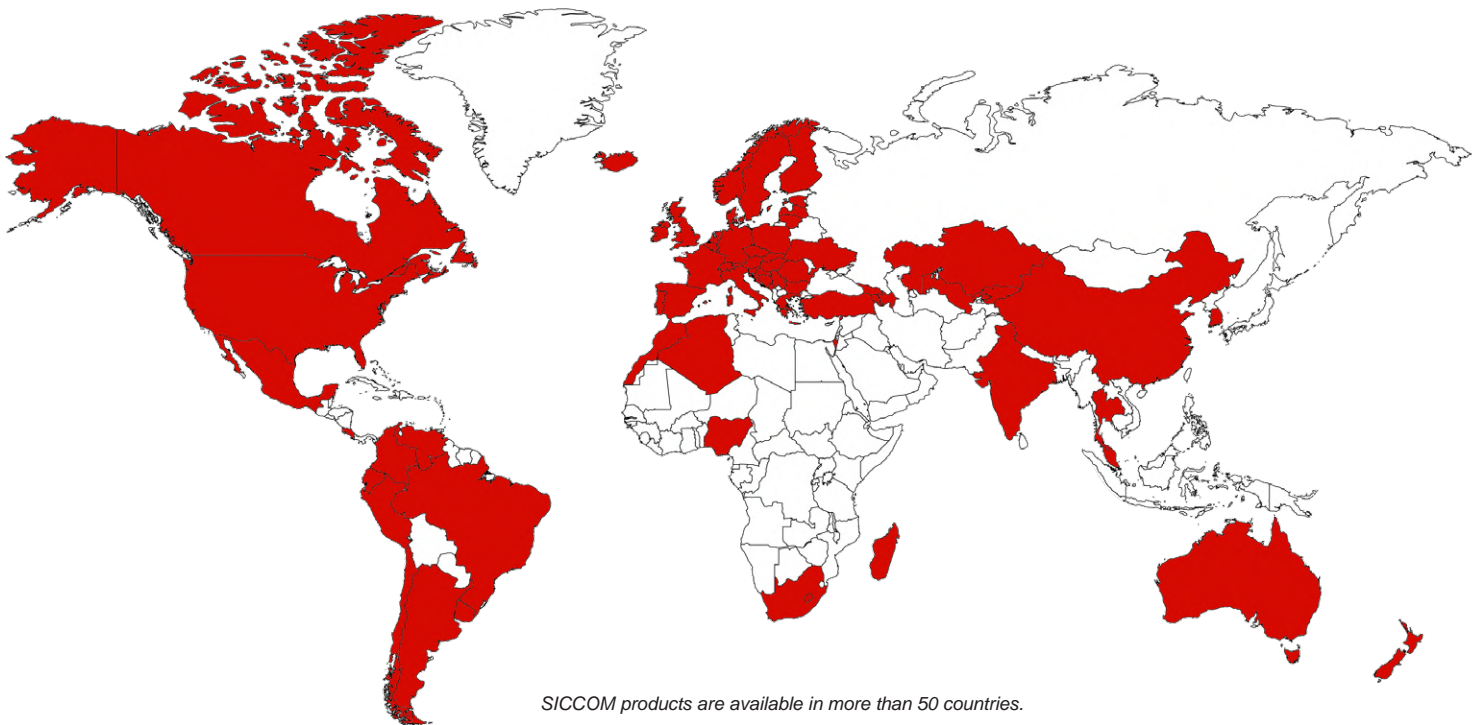

SICCOM products are available in more than 50 countries.



Headquarter (France)



Factory (Madagascar)





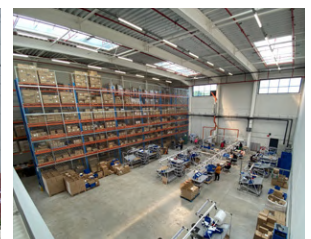





















Factory (China)



Factory (Bulgaria)

CONTENTS

 Air conditioning	 Refrigeration	 Heating	Range	Flowrate max	Discharge head max	Page
---	--	--	-------	--------------	--------------------	------

MINI PUMPS						
FLOWATCH® SILENCE DT20	NEW		PREMIUM	20 l/h	10 m	9
mini FLOWATCH® 2			PREMIUM	15 l/h	10 m	10
mini FLOWATCH® 2 COMFORT			PREMIUM	15 l/h	10 m	11
mini FLOWATCH® 3 WiFi			PREMIUM	15 l/h	10 m	12
ECO FLOWATCH®			ECO	13.2 l/h	10 m	13
ECO LINE			ECO	13.2 l/h	10 m	14
mini FLOWATCH® 1 EVO			ECO	13.2 l/h	10 m	15
MAXI ECO FLOWATCH®			ECO	40 l/h	10 m	16
MINI PUMPS IN TRUNKING						
FLOWATCH® SILENCE DESIGN DT20	NEW		PREMIUM	20 l/h	10 m	17
FLOWATCH® DESIGN			PREMIUM	15 l/h	10 m	18
ECO FLOWATCH® DESIGN			ECO	13.2 l/h	10 m	19
WALL-MOUNTED PUMPS						
FLOWITA EVO DT20	NEW		PREMIUM	20 l/h	10 m	21
FLOWITA EVO			ECO	13.2 l/h	10 m	22
FLOWATCH® VISION			PREMIUM	15 l/h	10 m	23
FLOWATCH® VISION DUO				PREMIUM	19 l/h	10 m
TANK & CENTRIFUGAL PUMPS						
FLOWATCH® TANK+ 1.2 / 2.5	NEW				PREMIUM	800 l/h 5.6 m (50Hz) 6 m (60Hz)
SUNNY FLOWATCH® CLIM					PREMIUM	15 l/h 10 m
SUNNY FLOWATCH® DUO					PREMIUM	19 l/h 10 m
Centrifugal pump CP08					PREMIUM	60 l/h 110 cm
Pump accessories						30
Level and proximity sensors						31

PREMIUM

Reliable, longlasting, silent and efficient, these pumps perfectly meet instalers and final users' expectations. They are all equipped with an **integrated alarm** (except CP08 and FLOWITA EVO DT20) and are among the **quietest on the market**.



ECO

A range of pumps **simple, reliable and easy-to-install**. Meet SICCOM expertise in **entry-level pumps** at prices even more attractive.

Find the right pump



FLOWWATCH® SILENCE DT20	✓	✓	✓	
mini FLOWWATCH® 2	✓	✓	✓	
mini FLOWWATCH® 2 COMFORT	✓	✓	✓	
mini FLOWWATCH® 3 WiFi	✓	✓	✓	
ECO FLOWWATCH®	✓	✓	✓	
ECO LINE	✓	✓	✓	
mini FLOWWATCH® 1 EVO	✓	✓	✓	
MAXI ECO FLOWWATCH®	✓	✓	✓	
FLOWWATCH® SILENCE DESIGN DT20	✓			
FLOWWATCH® DESIGN	✓			
ECO FLOWWATCH® DESIGN	✓			
FLOWITA EVO DT20	✓			
FLOWITA EVO	✓			
FLOWWATCH® VISION	✓			
FLOWWATCH® VISION DUO	✓			
FLOWWATCH TANK+ 1.2 / 2.5	✓	✓	✓	
SUNNY FLOWWATCH® CLIM	✓	✓	✓	
SUNNY FLOWWATCH® DUO	✓	✓	✓	
CENTRIFUGAL PUMP CP08				

Appliance			Specifications		Acoustic level
			Flowrate max	Discharge head max	
			20 l/h	10 m	
			15 l/h	10 m	
			15 l/h	10 m	
			15 l/h	10 m	
			13.2 l/h	10 m	
			13.2 l/h	10 m	
			13.2 l/h	10 m	
			40 l/h	10 m	
			20 l/h	10 m	
			15 l/h	10 m	
			13.2 l/h	10 m	
			20 l/h	10 m	
			13.2 l/h	10 m	
			15 l/h	10 m	
			19 l/h	10 m	
			800 l/h	5.6 m (50Hz) 6 m (60Hz)	
			15 l/h	10 m	
			19 l/h	10 m	
			60 l/h	110 cm	

NEW
2024 - 2025

**DISCOVER OUR
NEW PRODUCTS**

FLOWATCH SILENCE DT20



FLOWATCH SILENCE DESIGN DT20

**DT20
TECHNO**

16 dBA



Thanks to their exclusive new technology, FLOWATCH SILENCE DT20 and FLOWATCH SILENCE DESIGN DT20 are setting new global standards in condensate pumps.

 Lowest noise level on the market

FLOWITA EVO DT20

The easy and quick installation of a wall-mounted pump, in a more powerful (20 l/h) and quieter version!

DT20 technology promises a reliable, discreet and long-lasting product.

**DT20
TECHNO**



FLOWATCH TANK+ 1.2



The perfect all-purpose pump!

The FLOWATCH TANK+ is the ultimate version of our centrifugal tank pump. High flow rate (800 l/h max.), increased delivery head (5.6 m max.), IP24 sealing, and protection against condensate at pH > 2.5.

FLOWATCH TANK+ 2.5





SICCOM

A revolutionary condensate pump

FLOWATCH SILENCE DESIGN DT20

An absolute silence
for a perfect sleep



< 16 dBA

certified by LNE



MINI PUMPS

SICCOM mini pumps are designed to remove condensates from wall-mounted air conditioners. Thanks to a wide range, you can find a solution for all kind of environment. For a bedroom, choose our new revolutionary DT20 pumps.



Flowrate
max

















Discharge head
max



Noise level
rating



Alarm
equipped

					
		Flowrate max	Discharge head max	Noise level rating	Alarm equipped
FLOWATCH SILENCE DT20 PREMIUM	NEW	20 l/h	10 m		NC
mini FLOWATCH 2 PREMIUM		15 l/h	10 m		NO-NC
mini FLOWATCH 2 COMFORT PREMIUM		15 l/h	10 m		NO-NC
mini FLOWATCH 3 WiFi PREMIUM		15 l/h	10 m		NC
ECO FLOWATCH ECO		13.2 l/h	10 m		Optional
ECO LINE ECO		13.2 l/h	10 m		Optional
mini FLOWATCH 1 EVO ECO		13.2 l/h	10 m		NC
MAXI ECO FLOWATCH ECO		40 l/h	10 m		Optional
MINI PUMPS IN TRUNKING					
FLOWATCH SILENCE DESIGN DT20 PREMIUM	NEW	20 l/h	10 m		NC
FLOWATCH DESIGN PREMIUM		15 l/h	10 m		NO-NC
ECO FLOWATCH DESIGN ECO		13.2 l/h	10 m		Optional

FLOWATCH® SILENCE DT20 **SICCOM**

The perfect combination of silence, performance, reliability and simplicity.
For air conditioners up to 20kW / 68000BTU.
The new standard in condensate pumps!

Ref: DE20PMCD700



PREMIUM

NEW

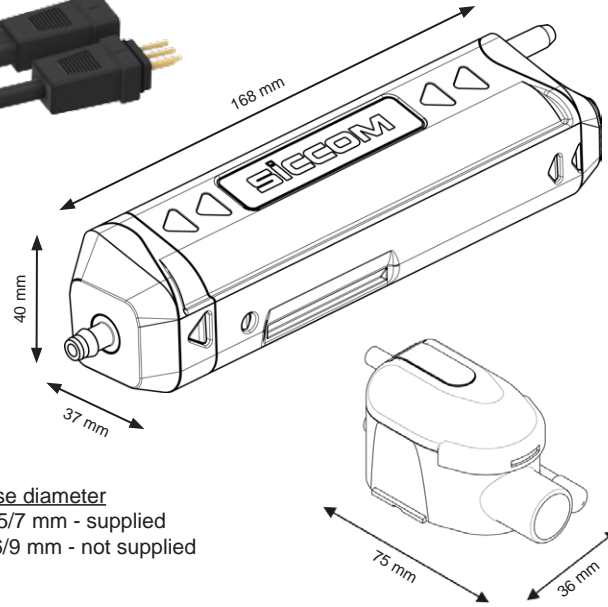
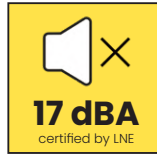

Hose diameter
Suction : 5/7 mm - supplied
Discharge : 6/9 mm - not supplied



SPECIFICATIONS

Flowrate max	20 l/h
Suction head max	3 m
Discharge head max	10 m
Electrical power	3W
Voltage	Univolt 100-240V 50/60Hz
Alarm	NC
Noise level	17 dBA
Protection rating	IP64
Operating cycle*	100%
Power / alarm cable	1.6 m
Dimensions	168 x 37 x 40 mm / 75 x 36 x 38 mm
Certifications	CE, UKCA, EAC

* The pump is able to run 100% of the time if necessary.

BENEFITS

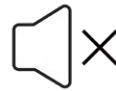

Extreme silence

An unrivalled user experience. No disturbance, even in the bedroom.

DT20 TECHNO

New technology

Ultra-low power consumption, unrivalled silence, exceptional reliability... Tested and approved!



IP64 protection

Protected against water splashes and dust.



Plug & Play connectors

Make installation and maintenance easier and faster.

3W

Very low power consumption

Only 3W power consumption, during operation only!



Mounting ring

The pump can be suspended with a clamp to facilitate its installation.



Stop siphoning included

Allows to avoid all risk of negative discharge and to secure the pump functioning over time.

CONTENTS

Pump - Reservoir with air-vent tube - Power / alarm cable - Stop Siphoning - Reservoir stand - Double-sided adhesives - Inlet tube - Suction tube 1.8 m - 3 clamps

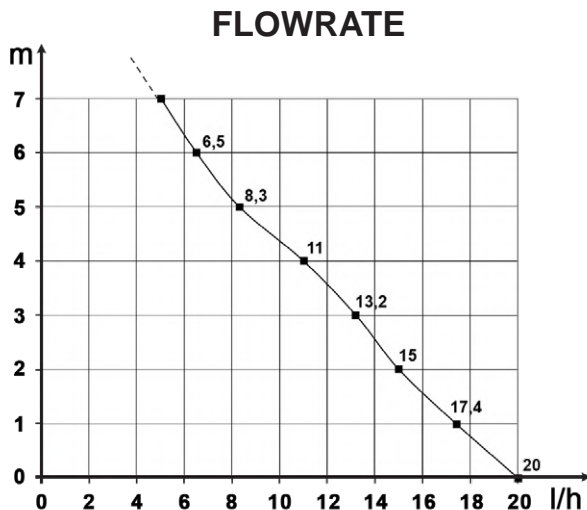

mini FLOWATCH® 2

SICCOM

Mini solenoid pump reliable and silent for the condensate removal of air conditioners up to 10kW / 36000BTU.

Ref: DE05LC4400



PREMIUM

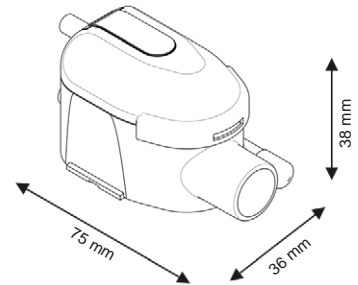
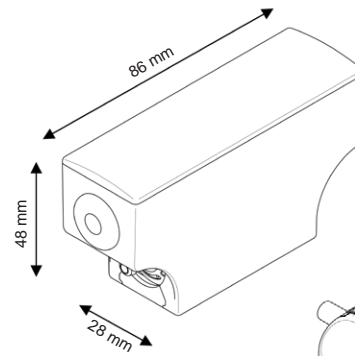

Hose diameter
Suction : 5/7 mm - supplied
Discharge : 6/9 mm - not supplied

SPECIFICATIONS

Flowrate max	15 l/h
Suction head max	2 m
Discharge head max	10 m
Electrical power	19W
Voltage	220-240V 50/60Hz
Alarm	NO-NC
Noise level	
Protection rating	IP64
Thermal protection	Yes
Operating cycle*	100%
Power / alarm cable	1.6 m
Dimensions	86 x 28 x 48 mm / 75 x 38 x 36 mm
Certifications	CE, UKCA, EAC, CMIM

* The pump is able to run 100% of the time if necessary.

FLOWRATE

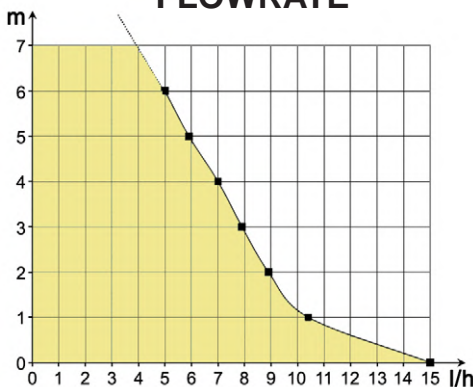

Recommended accessory



Kit COMFORT

Thanks to its patented foam casing, this kit reduces the noise level and makes the pump easier to install.

Ref: GC077G1027

BENEFITS



Very silent

Very silent pump (20.2 dBA), suitable for an installation in any room.



IP64 protection

Protected against water splashes and dust.



Plug & Play connectors

Make installation and maintenance easier.



Clear reservoir

Facilitates maintenance thanks to a quick visualization of the reservoir state.



Metal pump outlets

High solidity and reliability.



Accessories included

All accessories required for installation are included in the box.

CONTENTS



Pump - Reservoir with air-vent tube - Power / alarm cable - Reservoir stand - Double-side adhesive - Inlet tube - Suction tube 1.8m - 1 clamp

mini FLOWWATCH® 2 COMFORT

SICCOM

The best mini pump on the market in a quieter and easy-to-install version, for the condensate removal of air conditioners up to 10kW / 36000BTU.

Ref: DE05LCD750



PREMIUM



NEW
Stop Vibrations
included

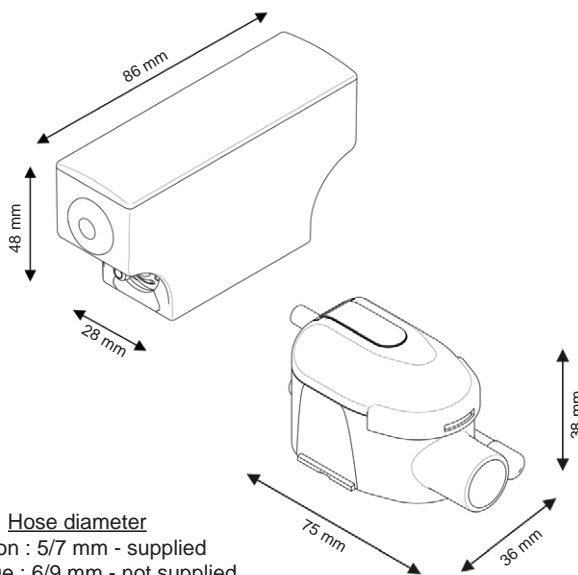

Hose diameter
Suction : 5/7 mm - supplied
Discharge : 6/9 mm - not supplied

SPECIFICATIONS

Flowrate max	15 l/h
Suction head max	2 m
Discharge head max	10 m
Electrical power	19W
Voltage	220-240V 50/60Hz
Alarm	NO-NC
Noise level	
Protection rating	IP64
Thermal protection	Yes
Operating cycle*	100%
Power / alarm cable	1.6 m
Dimensions	86 x 28 x 48 mm / 75 x 38 x 36 mm
Certifications	CE, UKCA, EAC, CMIM

* The pump is able to run 100% of the time if necessary.

BENEFITS



New casing Comfort

The new Comfort casing is composed of a custom-made patented foam.

It dampens pump vibrations and reduces the perceived noise level.



Reliability proven

The mini FLOWWATCH® 2, included, is a reliable and durable pump sold in more than 45 countries.



Very silent

Thanks to its casing, the pump is very quiet and suitable for installation in any room.



Stop Vibrations included **NEW**

Eliminates vibrations transmitted to the discharge pipe, thus reducing the noise level of the system!



Pump stand included

Make pump installation and maintenance easier.



Stop siphoning included

Allows to avoid all risk of negative discharge and to secure the pump functioning over time. Allows to avoid all risk of negative discharge and to



Plug & Play connectors

Make installation and maintenance easier.

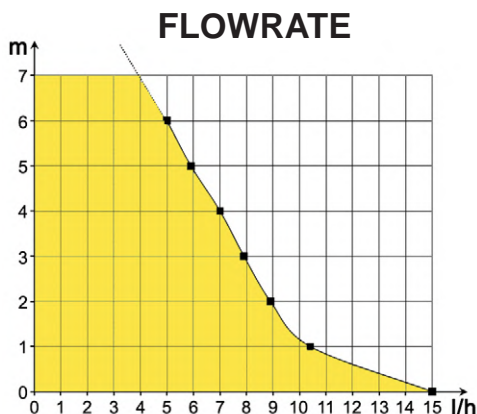

CONTENTS

Pump - Reservoir with air-vent tube - Power / alarm cable - Comfort casing - Pump stand - Reservoir stand - Stop Vibrations - Stop Siphoning - Double-sided adhesive - Inlet tube - Suction tube 1.8m - 4 clamps

mini FLOWWATCH® 3 WiFi

SICCOM

As a real product of predictive maintenance, the mini FLOWWATCH® 3 WiFi allows to remotely supervise a fleet of pumps and to anticipate a maintenance on a pump or an air conditioner. For air conditioners up to 10kW / 36000BTU.

Ref: DE05WFCC760



PREMIUM

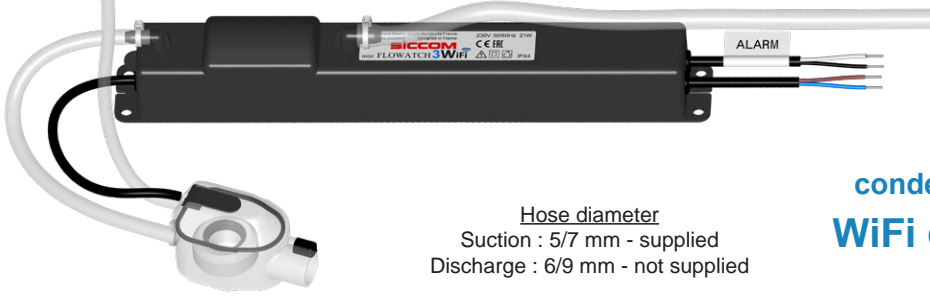

Hose diameter
Suction : 5/7 mm - supplied
Discharge : 6/9 mm - not supplied

The first
condensate pump
WiFi connected



Monitor your **pump fleet** in the blink of an eye!

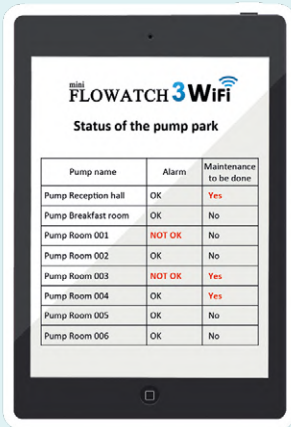

View all pump datas

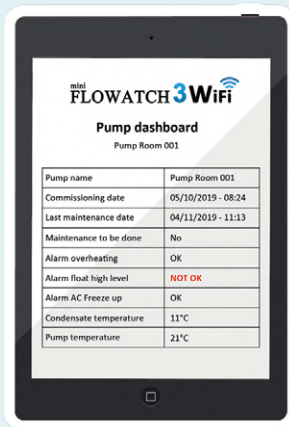

The pump sends you an email when an alarm triggers!

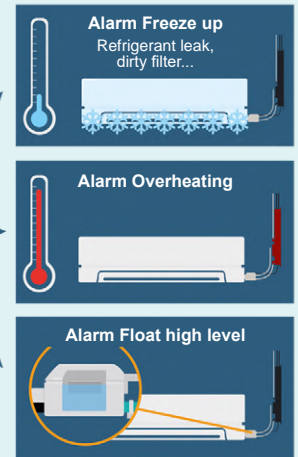
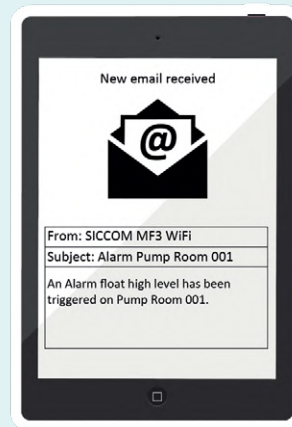

SPECIFICATIONS

Flowrate max	15 l/h
Suction head max	2 m
Discharge head max	10 m
Electrical power	21W
Voltage	220-240V 50/60Hz
Alarm	NC
Noise level	
Protection rating	IPX4
Thermal protection	Yes
Operating cycle*	100%
Power / alarm cable	1.6 m
Dimensions	272 x 35 x 43 mm / 75 x 38 x 36 mm
Certifications	CE, UKCA, EAC

* The pump is able to run 100% of the time if necessary.

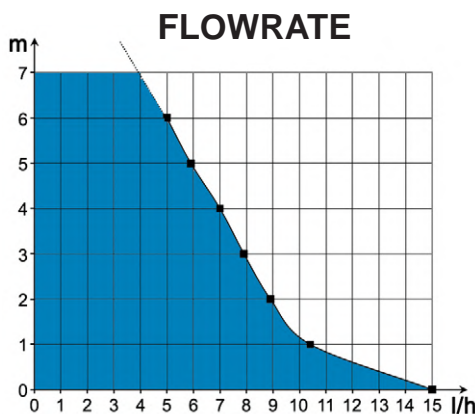

BENEFITS



Web interface

The interface is accessible from a computer, smartphone, or tablet and requires no software or application installation.



Email sending in case of alarm

Be notified immediately in the event of a malfunction (3 alarm cases).



Real-time supervision

Access a wealth of information about your pump fleet in just a few clicks.



Pump interconnection

Create a network of pumps, and allow them to communicate with each other for more productive management of your pump fleet.



Extremely silent

One of the quietest pump of our range (18.6 dBA), for an installation in any room.



Stop siphoning included

Allows to avoid all risk of negative discharge and to secure the pump functioning over time.

CONTENTS

Pump - Reservoir with air-vent tube - Reservoir stand - Double-side adhesives - Inlet tube - Suction tube 1.8m - Clamps

ECO FLOWATCH®

SICCOM

Mini solenoid pump simple and economic for the condensate removal of air conditioners up to 10kW / 36000BTU.

Ref: DE05LCC190



ECO

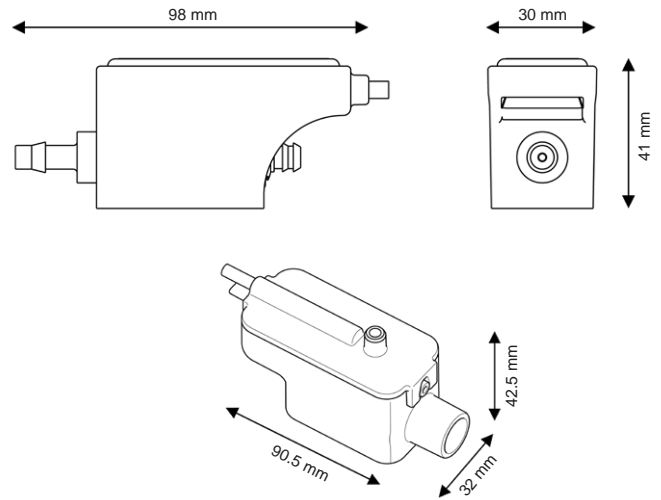
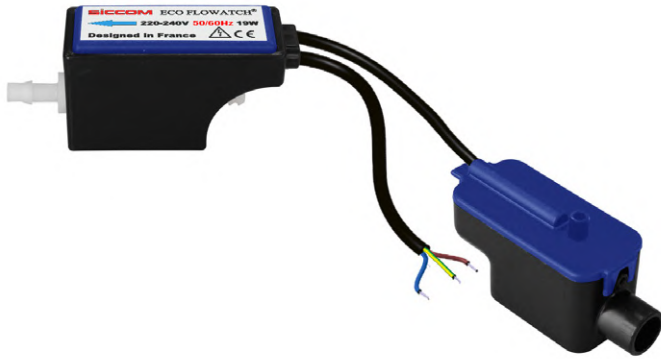

Hose diameter
Suction : 6/9 mm - not supplied
Discharge : 6/9 mm - not supplied

SPECIFICATIONS

Flowrate max	13.2 l/h
Suction head max	1.5 m
Discharge head max	10 m
Electrical power	19W
Voltage	220-240V 50/60Hz
Alarm*	No alarm
Noise level	
Protection rating	IP20
Thermal protection	Yes
Operating cycle**	100%
Power cable	1.5 m
Dimensions	98 x 30 x 41 mm / 90 x 32 x 42 mm
Certifications	CE, EAC

* Alarm option available on request.

** The pump is able to run 100% of the time if necessary.

BENEFITS



WATERPROOF removable reservoir
The reservoir, which can be removed for easy maintenance, now has a waterproof seal!



Integrated filter
Plastic filter integrated to the reservoir. It prevents big impurities to damage the pump.



Accessories included
All necessary accessories are included in the box.



Compact pump
Very small, pump and reservoir are easy to install.

FLOWRATE

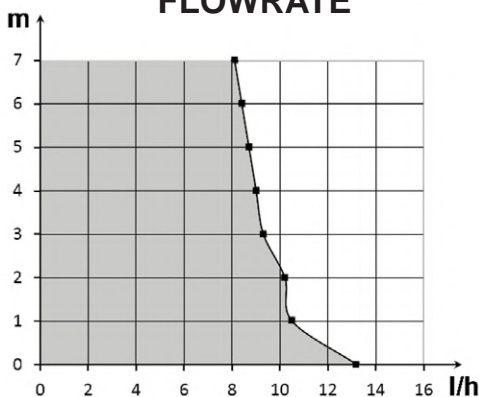

CONTENTS

Pump - Reservoir - Double-side adhesive for reservoir fixing - Inlet tube - 3 clamps



ECO LINE

SICCOM

Mini in-line pump (solenoid), ultra compact and easy to install, for the condensate removal of air conditioners up to 10kW / 36000BTU.

Ref: DE05SCC600



ECO

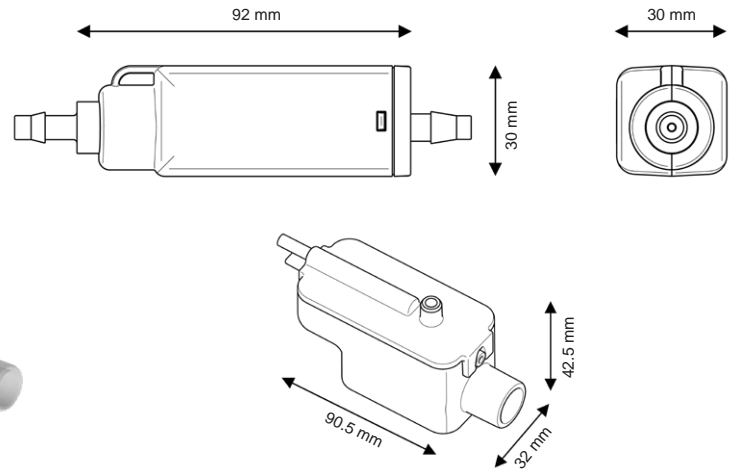
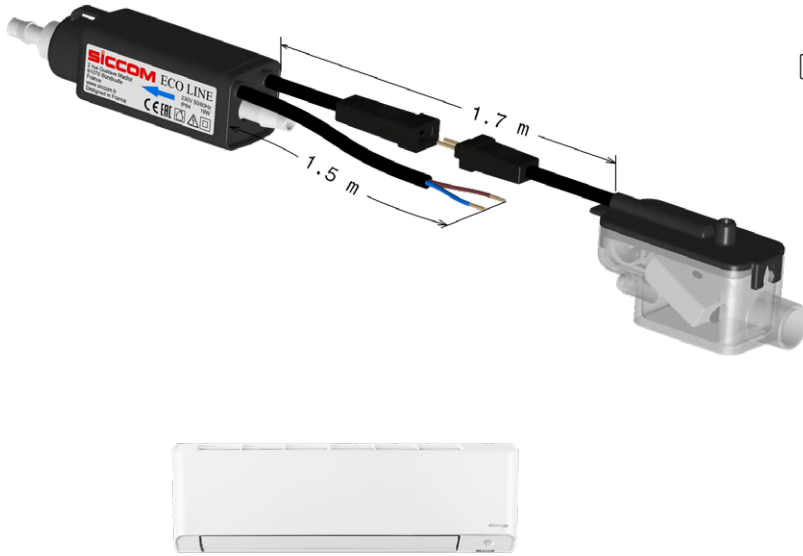

Hose diameter
Suction : 6/9 mm - not supplied
Discharge : 6/9 mm - not supplied

SPECIFICATIONS

Flowrate max	13.2 l/h
Suction head max	1.5 m
Discharge head max	10 m
Electrical power	19W
Voltage	220-240V 50/60Hz
Alarm*	No alarm
Noise level	
Protection rating	IP64
Thermal protection	Yes
Operating cycle**	100%
Power cable	1.5 m
Dimensions	92 x 30 x 30 mm / 90 x 32 x 42 mm
Certifications	CE, UKCA, EAC

* Alarm option available on request.
** The pump is able to run 100% of the time if necessary.

FLOWRATE

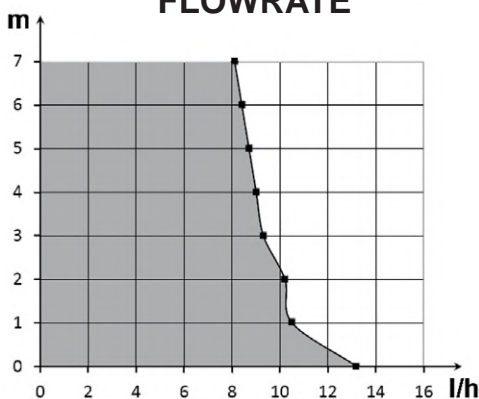

BENEFITS

ULTRA COMPACT pump

The most compact pump of the market!
Easy installation in a duct or inside the air conditioner.



IP64 protection

Protected against water splashes and dust.

Plug & Play connectors

Make installation and maintenance easier.



WATERPROOF removable reservoir

The reservoir, which can be removed for easy maintenance, now has a waterproof seal!



Hanging bracket

This astucious hook allows to fix or hang the pump wherever you want (duct, false ceiling, inside de unit...).



Accessories included

All necessary accessories are included in the box.



CONTENTS

Pump - Reservoir - Double-side adhesive for reservoir fixing - Inlet tube - 3 clamps



mini FLOWATCH® 1 EVO

SICCOM

Economical mini solenoid pump, with alarm, for the condensate removal of air conditioners up to 10kW / 36000BTU.

Ref: DE05LCD600



ECO

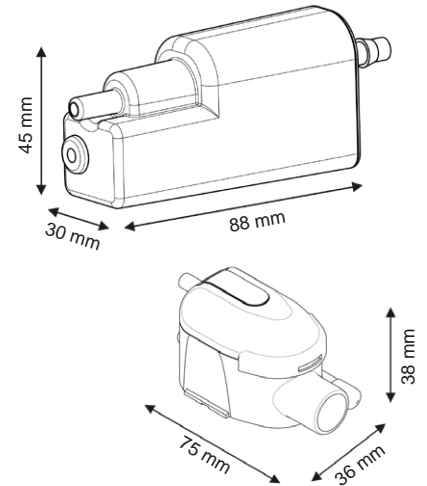

Hose diameter
Suction : 5/7 mm - supplied
Discharge : 6/9 mm - not supplied

SPECIFICATIONS

Flowrate max	13.2 l/h
Suction head max	1.5 m
Discharge head max	10 m
Electrical power	19W
Voltage	220-240V 50/60Hz
Alarm	NC
Noise level	
Protection rating	IP24
Thermal protection	Yes
Operating cycle*	100%
Power / alarm cable	1.5 m
Dimensions	88 x 30 x 45 / 75 x 36 x 38 mm
Certifications	CE, UKCA, EAC

* The pump is able to run 100% of the time if necessary.

BENEFITS



Plus & Play connectors

Make installation and maintenance easier.



Clear reservoir

Facilitates maintenance thanks to a quick visualization of the reservoir state.



Removable integrated filter

The reservoir has a metal filter that can be easily removed for quick cleaning.



Alarm function

The NC alarm on the mini FLOWATCH® 1 EVO allows to cut off the air conditioner power supply in the event of condensate overflow.



IP24 protection

Protected against water splashes.



Accessories included

Necessary accessories are supplied in the box.

FLOWRATE

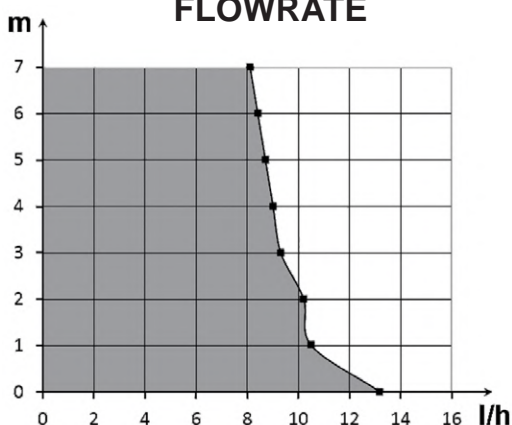

CONTENTS

Pump - Reservoir with air-vent tube
- Double-side adhesive - Inlet tube -
Suction tube 1.5m - 3 clamps

MAXI ECO FLOWATCH®

SICCOM

Maxi solenoid pump, compact and powerful, for the condensate removal of air conditioners up to 30kW / 100 000BTU.

Ref: DE40LCC300



ECO

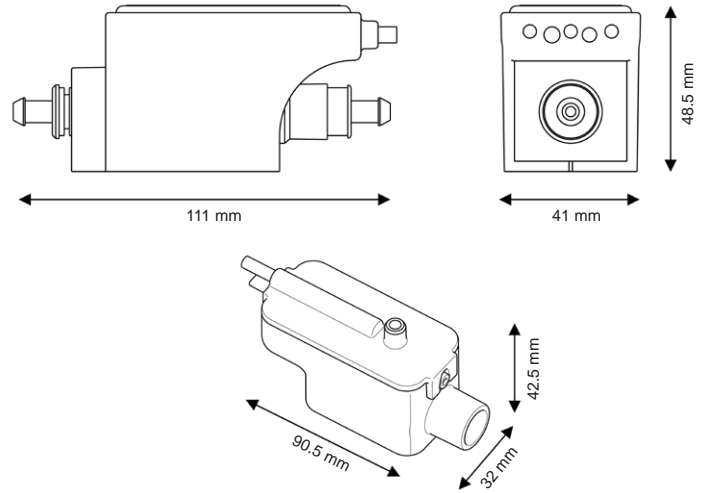
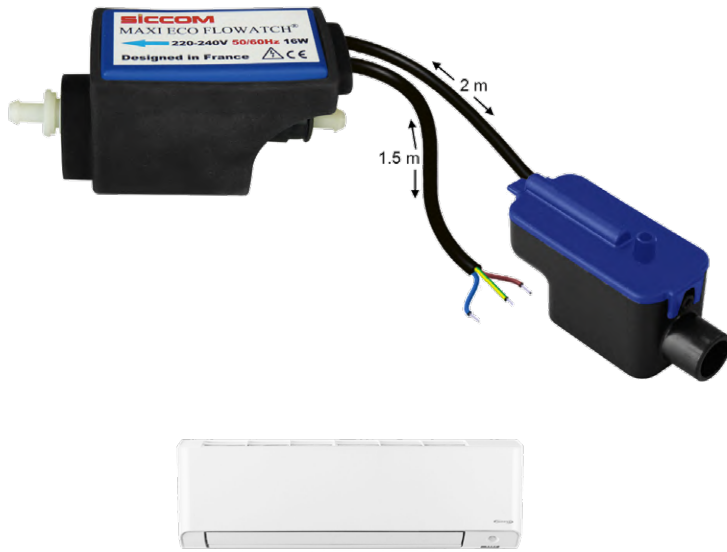

Hose diameter
Suction : 6/9 mm - not supplied
Discharge : 6/9 mm - not supplied

SPECIFICATIONS

Flowrate max	40 l/h
Suction head max	2 m
Discharge head max	10 m
Electrical power	16W
Voltage	220-240V 50/60Hz
Alarm*	No alarm
Noise level	
Protection rating	IP20
Thermal protection	Yes
Operating cycle**	100%
Power cable	1.5 m
Dimensions	111 x 41 x 48 mm / 90 x 32 x 42 mm
Certifications	CE, EAC

* Alarm option available on request.
** The pump is able to run 100% of the time if necessary.

FLOWRATE

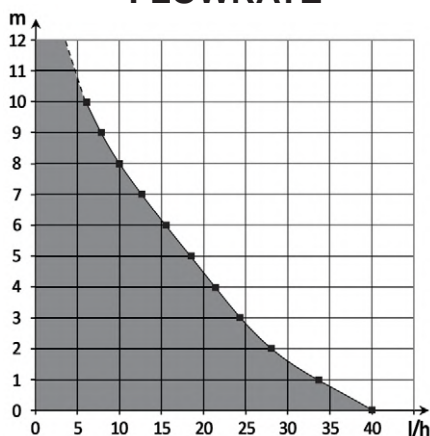

BENEFITS



High efficiency

Flowrate 40 l/h
Discharge head 10 m



Silent

The only pump of the world to offer such a flowrate with such a low noise.



WATERPROOF removable reservoir

The reservoir, which can be removed for easy maintenance, now has a waterproof seal!



Integrated filter

Plastic filter integrated to the reservoir. It prevents big impurities to damage the pump.



Accessories included

All necessary accessories are included in the box.



Compact pump

Very small, pump and reservoir are easy to install.



CONTENTS

Pump - Reservoir - Double-side adhesive for reservoir fixing - Inlet tube - 3 clamps

FLOWATCH® SILENCE DESIGN DT20 **SICCOM**

The quietest trunking pump in the world!
A complete kit, with a quality trunking and all the accessories needed for installation! For air conditioners up to 20kW / 68000BTU.

Ref:DE20PMCE450



PREMIUM
NEW



Hose diameter
Suction : 5/7 mm - supplied
Discharge : 6/9 mm - not supplied

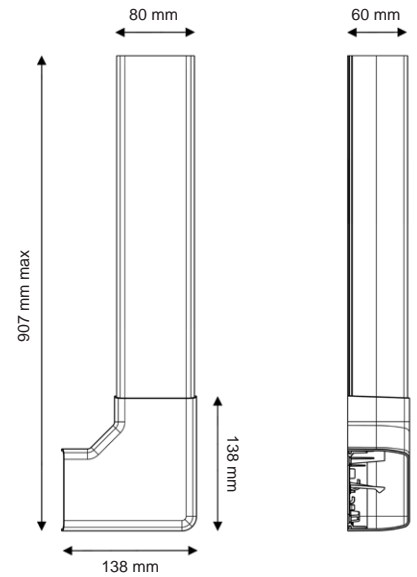

SPECIFICATIONS

Flowrate max	20 l/h
Suction head max	3 m
Discharge head max	10 m
Electrical power	3W
Voltage	Univolt 100-240V 50/60Hz
Alarm	NC
Noise level	16 dBA
Protection rating	IP64
Operating cycle*	100%
Power / alarm cable	1.6 m
Trunking dimensions	80 x 60 mm
Certifications	CE, UKCA, EAC

* The pump is able to run 100% of the time if necessary.

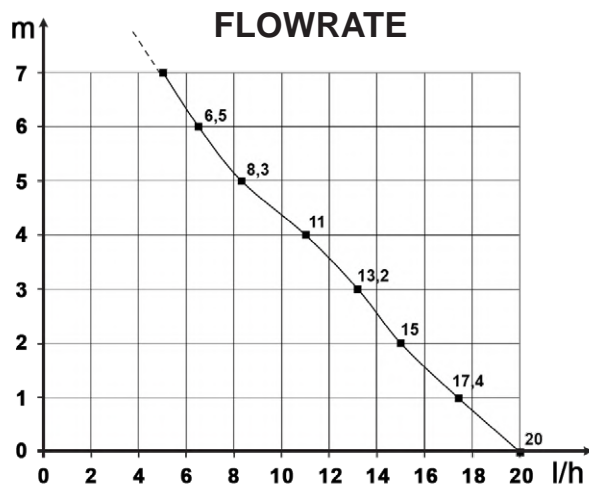

BENEFITS



Extreme silence

The trunking pump
THE MOST SILENT IN THE WORLD !



FLOWATCH® SILENCE DT20 included

Quite simply, the new standard on the market.

DT20 TECHNO

New Technology

Ultra-low power consumption, unrivalled silence, exceptional reliability... Tested and approved!

3W

Very low power consumption

Only 3W power consumption, during operation only!



Custom-made pump casing

For easy installation and perfect integration into the trunking.



New trunking

A market-standard trunking system that's aesthetically pleasing, easy to install and comes with a wide range of accessories.



Stop siphoning included

Allows to avoid all risk of negative discharge and to secure the pump functioning over time.



Plug & Play connectors

Make installation and maintenance easier.

CONTENTS

Trunking with elbow - Finishing gasket - Finishing ceiling plate - Pump in absorber bracket - Stop Siphoning - Reservoir with air-vent tube - Power / alarm cable - Inlet tube - Suction tube 0.25m - Screws and rawlplugs



Complete kit, in-duct pump, for the condensate removal of air conditioners up to 10kW / 36000BTU.

Ref: DE05LCF300



PREMIUM

NEW VERSION

Standard size

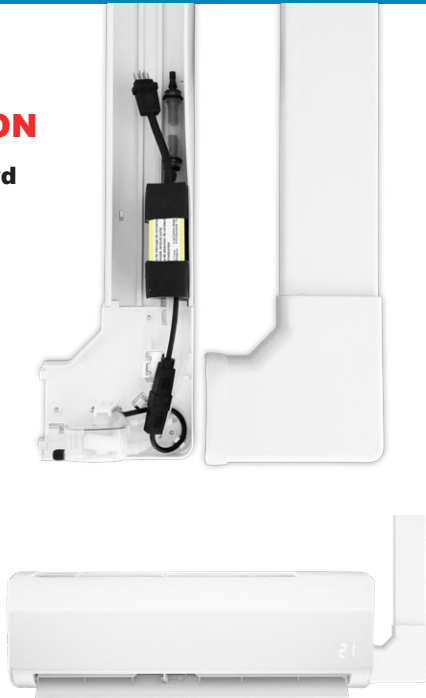

SPECIFICATIONS

Flowrate max	15 l/h
Discharge head max	10 m
Electrical power	19W
Voltage	220-240V 50/60Hz
Alarm	NO-NC
Noise level	
Protection rating	IP64
Thermal protection	Yes
Operating cycle*	100%
Power / alarm cable	1.6 m
Trunking dimensions	80 x 60 mm
Certifications	CE, UKCA, EAC

* The pump is able to run 100% of the time if necessary.

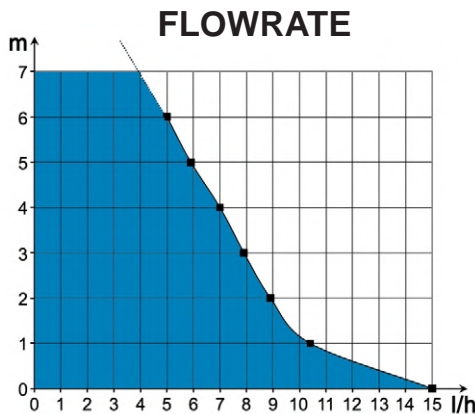

Recommended accessory

Connection extension kit

Allows the pump to be moved into a false ceiling, thus reducing the noise level.

Ref: GC1KCTC710



Hose diameter
Suction : 5/7 mm - supplied
Discharge : 6/9 mm - not supplied

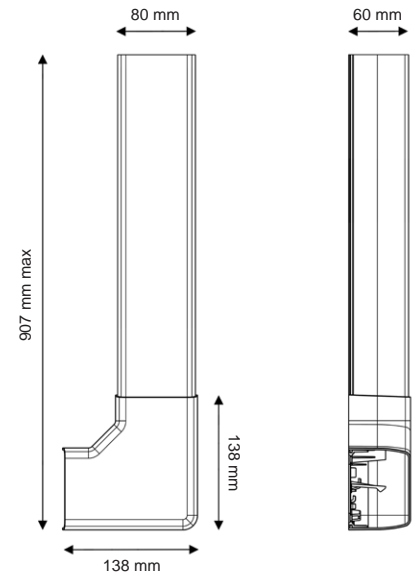

BENEFITS



mini FLOWATCH® 2 included

It assures a high reliability and an easy maintenance.



Very silent

Very silent pump (20.2 dBA), suitable for an installation in any room.



Stop Vibrations included

Eliminates vibrations transmitted to the discharge pipe, thus reducing the noise level of the system!



Custom-made pump case

For easy installation, reduced noise level and perfect integration into the trunking.



Stop siphoning included

Allows to avoid all risk of negative discharge and to secure the pump functioning over time.



New trunking (standard size)

A market-standard trunking, attractive, easy to install, and with many available accessories.



Kit pre-assembled

Pump is already installed in its duct. Installation is easy and quick.

CONTENTS



Duct with elbow- Finishing gasket - Finishing ceiling plate - Pump in absorber bracket - Stop Vibrations - Stop Siphoning - Reservoir with air-vent tube - Power / alarm cable - Reservoir stand - Inlet tube - Suction tube 0.25m - Screws and rawlplugs

ECO FLOWATCH® DESIGN

Complete kit, in-duct pump, for the condensate removal of air conditioners up to 10kW / 36000BTU.

Ref: DE05LCD320



ECO

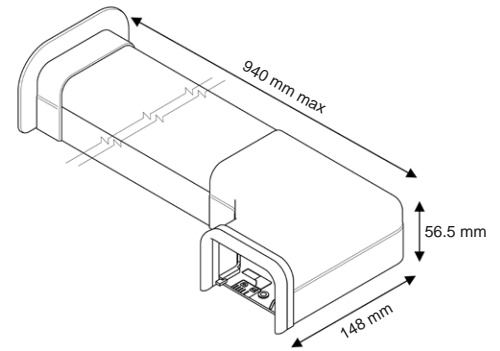
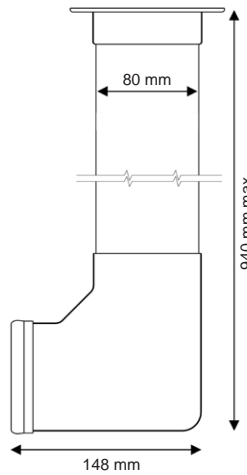
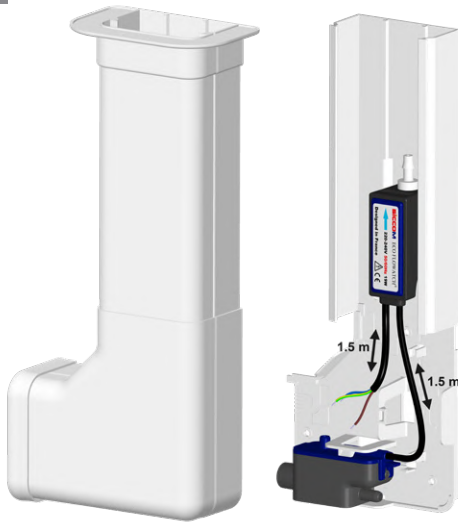

Hose diameter
Suction : 6/9 mm - not supplied
Discharge : 6/9 mm - not supplied



SPECIFICATIONS

Flowrate max	13.2 l/h
Suction head max	1.5 m
Discharge head max	10 m
Electrical power	19W
Voltage	220-240V 50/60Hz
Alarm	No alarm
Noise level	
Protection rating	IP20
Thermal protection	Yes
Operating cycle*	100%
Power cable	1.5 m
Trunking dimensions	80 x 55 x 800 m
Certifications	CE, EAC

* The pump is able to run 100% of the time if necessary.

BENEFITS

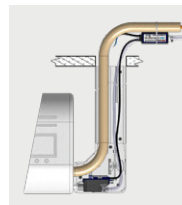

Possibility to move the pump away
Thanks to its 1.5 m cable, the pump unit can be moved away to reduce the noise level and facilitate installation.



WATERPROOF removable reservoir
The reservoir, which can be removed for easy maintenance, now has a waterproof seal!



Integrated filter
Plastic filter integrated to the reservoir. It prevents big impurities to damage the pump.



Accessories included
All necessary accessories are included in the box.



Compact pump
Very small, pump and reservoir are easy to install.



Nice design
Thanks to its shape and its finishing accessories (included), the ECO FLOWATCH® DESIGN offers great aesthetics qualities.

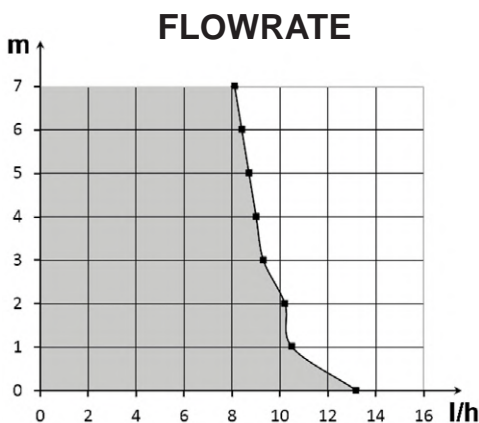

CONTENTS



Duct with elbow- Finishing gasket - Finishing ceiling plate - Pump ECO FLOWATCH - Reservoir - Inlet tube - Double-side adhesive - Clamps

WALL-MOUNTED PUMPS

Wall-mounted pumps are easy and quick to install. Screw it to the wall, make the hydraulic and electrical connections, and you're done!



Flowrate
max



Discharge head
max



Noise level
rating



Alarm
equiped

		NEW			
	FLOWITA EVO DT20 PREMIUM		20 l/h	10 m	Optional
	FLOWITA EVO ECO		13.2 l/h	10 m	Optional
	FLOWATCH VISION PREMIUM		15 l/h	10 m	NO-NC
	FLOWATCH VISION DUO PREMIUM		19 l/h	10 m	NO-NC

Discover the 2 types of wall-mounted condensate pumps made by SICCOM. FLOWATCH® VISION can be installed under the air conditioner or on its side. FLOWITA EVO is installed discreetly under the unit.



FLOWITA EVO DT20

A very silent, efficient, reliable and easy-to-install wall-mounted pump.
For air conditioners up to 20kW / 68000BTU.
The new standard in condensate pumps!

Ref: DE20PMCE400



PREMIUM

NEW

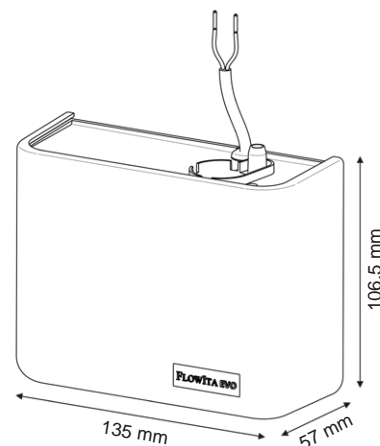

Hose diameter
Discharge : 6/9 mm - not supplied

SPECIFICATIONS

Flowrate max	20 l/h
Discharge head max	10 m
Electrical power	3W
Voltage	Univolt 100-240V 50/60Hz
Alarm*	Optional
Noise level	
Protection rating	IP24
Operating cycle**	100%
Power cable	0.8 m
Tank capacity	170 ml
Dimensions	135 x 57 x 106.5 mm
Certifications	CE, EAC

* Alarm option available on request.

** The pump is able to run 100% of the time if necessary.

BENEFITS

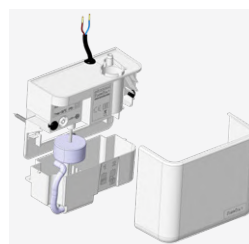

The FLOWITA EVO DT20 can be disassembled in seconds!

Front panel, tank, suction tube... all the elements are removable.

Installation and maintenance has never been so quick and easy!



Extreme silence

The most silent wall-mounted pump on the market, for an unrivalled user experience.

DT20 TECHNO

New technology

Ultra-low power consumption, unrivalled silence, exceptional reliability... Tested and approved!

3W

Very low power consumption

Only 3W power consumption, during operation only!



Quick installation

The FLOWITA EVO DT20 can be installed easily and quickly underneath any air conditioner.



IP24 protection

Protected against water splashes.

FLOWITA DT36

FLOWITA EVO DT36 on request

A more powerful version of the FLOWITA EVO (36 l/h) for heavier equipment.

CONTENTS

Pump - Screws and rawplugs

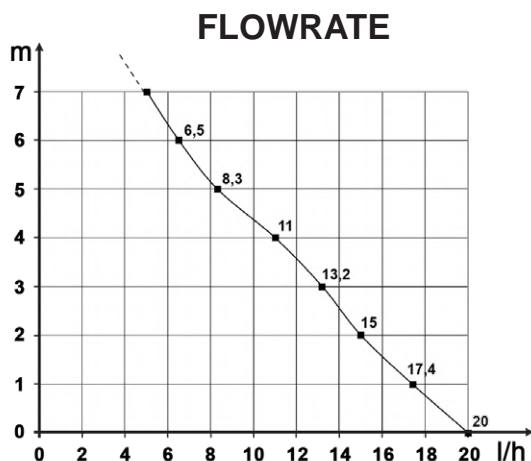

FLOWITA EVO

Wall-mounted monobloc pump, dismantlable, for the condensate removal from air conditioners up to 10kW / 36000BTU.

Ref: DE05LCC440



ECO

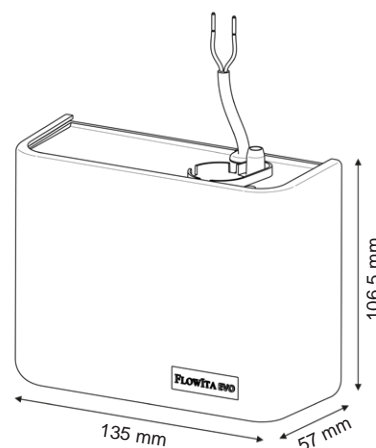

Hose diameter
Discharge : 6/9 mm - not supplied



SPECIFICATIONS

Flowrate max	13.2 l/h
Discharge head max	10 m
Electrical power	19W
Voltage	220-240V 50/60Hz
Alarm*	Optional
Noise level	
Protection rating	IP24
Thermal protection	Yes
Operating cycle**	100%
Power cable	0.8 m
Tank capacity	170 ml
Dimensions	135 x 57 x 106.5 mm
Certifications	CE, EAC

* Alarm option available on request.

** The pump is able to run 100% of the time if necessary.

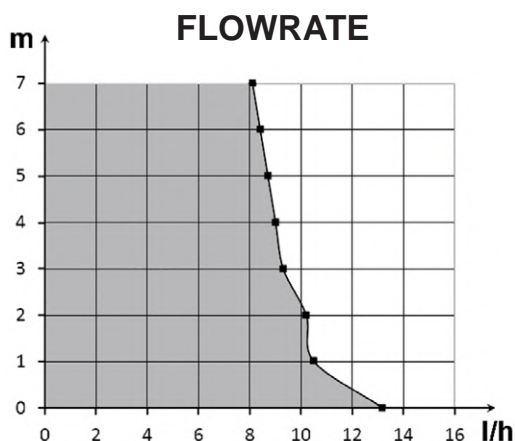

BENEFITS

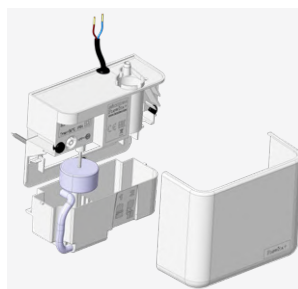

Dismountable

The FLOWITA EVO can be disassembled in seconds!

Front panel, tank, suction tube... all the elements are removable.

Installation and maintenance has never been so quick and easy!

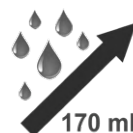

170ml reservoir

Its large reservoir allows the pump to operate optimally: larger and less frequent pumping cycles.



Very silent

One of the most discreet wall-mounted pump on the market!



Quick installation

The FLOWITA EVO can be installed easily and quickly underneath any air conditioner.



IP24 protection

Protected against water splashes.

CONTENTS

Pump - Screws and rawplugs



FLOWATCH® VISION

SICCOM

The only monoblock wall pump of the market, installed horizontally or vertically, for the condensate removal of air conditioners up to 10kW / 36000BTU.

Ref: DE05LCB900



PREMIUM

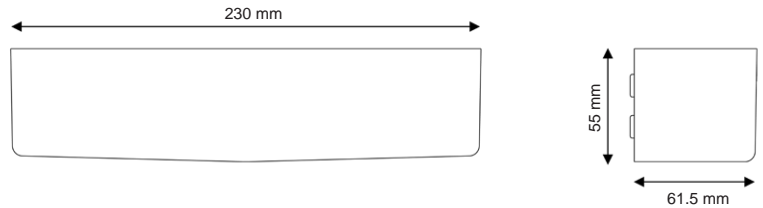

Hose diameter
Discharge : 6/9 mm - not supplied



BENEFITS

4 possible installations



World first - Can be installed horizontally or vertically, on the right or on the left of the air conditioner.

Easy maintenance



Access to the pump elements (reservoir, tubes etc.) is made by removing the cover.

Very silent



Very silent pump, suitable for an installation in any room.

Record size



Thanks to its small size, the FLOWATCH® VISION is the most discreet and aesthetic monoblock wall pump of the market.

Reservoir with removing filter

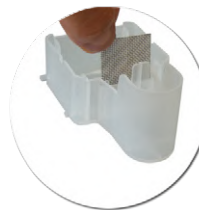

Prevents dust and particles to damage the pump. Easy to clean.

SPECIFICATIONS

Flowrate max	15 l/h
Discharge head max	10 m
Electrical power	19W
Voltage	220-240V 50/60Hz
Alarm	NO-NC
Noise level	
Protection rating	IPX3
Thermal protection	Yes
Operating cycle*	100%
Power / alarm cable	1.4 m
Dimensions	230 x 61.5 x 55 mm
Certifications	CE, UKCA, EAC

* The pump is able to run 100% of the time if necessary.

FLOWRATE

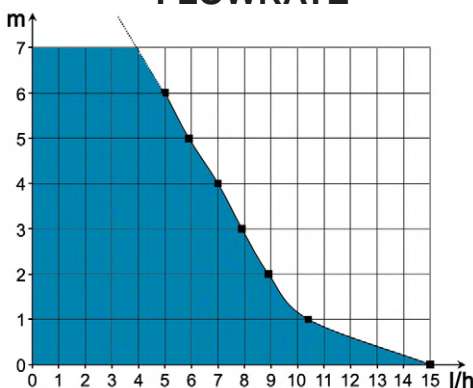

CONTENTS



Pump - Reservoir for horizontal installation - Reservoir for vertical installation - Inlet tube - Screws and raw/plugs - 1 clamp

FLOWATCH® VISION DUO

SICCOM

Monoblock wall pump (solenoid), silent and innovative, for the condensate removal of gas condensing boilers up to 60kW / 200 000BTU.

Ref: DE05LCC510



PREMIUM

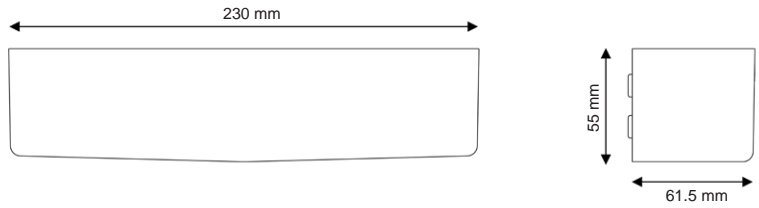

Hose diameter
Discharge : 6/9 mm - not supplied

pH > 2.5



SPECIFICATIONS

Flowrate max	19 l/h
Discharge head max	10 m
pH tolerated	pH > 2.5
Electrical power	19W
Voltage	220-240V 50/60Hz
Alarm	NO-NC
Noise level	
Protection rating	IPX3
Thermal protection	Yes
Operating cycle*	100%
Power / alarm cable	1.4 m
Dimensions	230 x 61.5 x 55 mm
Certifications	CE, EAC

* The pump is able to run 100% of the time if necessary.

BENEFITS



4 possible installations

World first - Can be installed horizontally or vertically, on the right or on the left of the boiler.



Very silent

Very silent pump, suitable for an installation in any room.



Very easy maintenance

Access to the pump elements (reservoir, tubes etc.) is made by removing the cover.



Record size

Thanks to its small size, the FLOWATCH® VISION DUO is the most discreet and aesthetic moboblock wall pump of the market.



Reservoir with removable filter

Prevent dust and particles to damage the pump. Easy to clean.

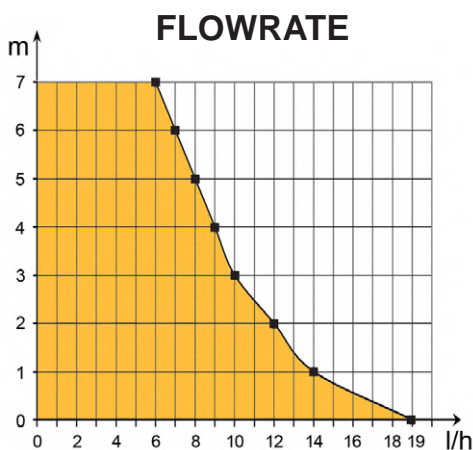

CONTENTS

Pump - Inlet tube - Screws and rawplugs - 1 clamp

TANK & CENTRIFUGAL PUMPS

SICCOM manufactures tank pumps with different technologies depending on the installation environment. Find out our range of all-purpose tank pumps for air conditioning, refrigerating and heating equipments.



Flowrate
max



Discharge head
max



Noise level
rating



Alarm
equiped

	NEW			
FLOWATCH TANK+ PREMIUM		800 l/h	5.6 m	 NO-NC
SUNNY FLOWATCH CLIM PREMIUM		15 l/h	10 m	 NO
SUNNY FLOWATCH DUO PREMIUM		19 l/h	10 m	 NO-NC
CP08 PREMIUM		60 l/h	110 cm	 No alarm



FLOWATCH® TANK+ 1.2 and FLOWATCH® TANK+ 2.5 are powerful centrifugal tank pumps for all types of condensates (pH > 2.5)



SUNNY FLOWATCH® CLIM, by using a piston pump, features a low noise level and a compact size.



SUNNY FLOWATCH® DUO is a piston tank pump dedicated to low and medium-power gas condensing boilers.



The centrifugal pump CP08 is a universal pump model for cassette air conditioners.

FLOWATCH TANK+ 1.2 / 2.5

SICCOM

Centrifugal tank pump for the removal of condensates from air conditioners, refrigerated displays or gas condensing boilers.

Ref ECOTANK+ 1.2 50Hz: DE12QCC610
 Ref ECOTANK+ 2.5 50Hz: DE25QCC620
 Ref ECOTANK+ 2.5 60Hz: DE25QCD140



PREMIUM

NEW



pH > 2.5



BENEFITS



High efficiency

Flowrate max: 800 l/h
 Discharge head max: 5.6 m



IP24 protection

The pump is protected against water splashes.



Universal electric plug

Power/alarm cable can be taken off, making easy installation and maintenance.



Outlet for 6/9 or 9/12 mm tube

Thanks to its connector supplied, the discharge can be made with a 6/9mm or a 9/12mm tube.



High capacity tank

Thanks to its 2.5 l tank, the FLOWATCH TANK+ 2.5 reduces the number of pumping cycles and answers to a great deal of applications.



Compact tank pump

With only 129mm height, the FLOWATCH TANK+ 1.2 fits easily in any space.



Reversible tank

Turning the tank allows to fit in any configuration.

SPECIFICATIONS

	50Hz version	60Hz version
Flowrate max	800 l/h	800 l/h
Discharge head max	5.6 m	6 m
pH tolerated	pH > 2.5	pH > 2.5
Condensates max temp.	60°C	60°C
Electrical power	65W	65W
Voltage	230V 50Hz	230V 60Hz
Alarm	NO-NC	NO-NC
Noise level		
Protection rating	IP24	IP24
Thermal protection	Yes	Yes
Operating cycle*	30%	30%
Cable lenght	1.5 m	1.5 m
Dimensions ECOTANK+ 1.2	280 x 130 x 129 mm	/
Dimensions ECOTANK+ 2.5	280 x 130 x 159 mm	
Certifications	CE, UKCA, EAC	CE

* The pump is able to run 30% of the time if necessary.

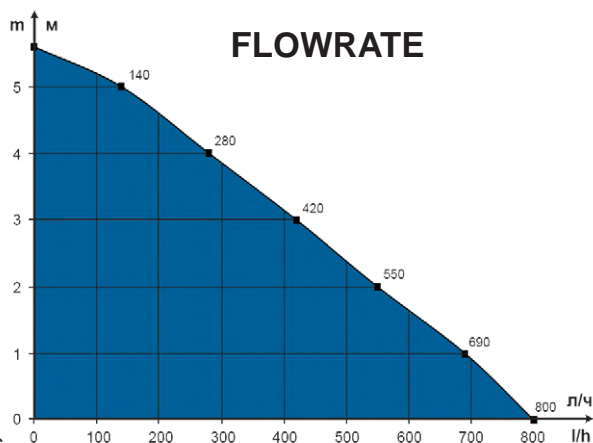

CONTENTS

Pump - Cable power / alarm - 6/9mm outlet adaptor - Screws and rawplugs - PVC clear tube 6m (only in 60Hz version)

SUNNY FLOWATCH® CLIM

SICCOM

Mini tank pump (solenoid) for the condensate removal of air conditioners up to 10kW / 36000BTU.

Ref: DE05RCC060



PREMIUM

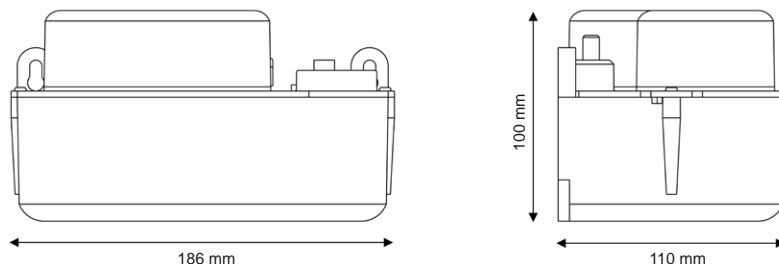

Hose diameter
Discharge : 6/9 mm - not supplied



SPECIFICATIONS

Flowrate max	15 l/h
Discharge head max	10 m
Electrical power	19W
Voltage	220-240V 50/60Hz
Alarm	NO-NC
Noise level	
Protection rating	IPX4
Thermal protection	Yes
Operating cycle*	100%
Power / alarm cable	1.5 m / 1.3 m
Dimensions	186 x 110 x 100 mm
Certifications	CE, EAC

* The pump is able to run 100% of the time if necessary.

BENEFITS



Very silent

Very silent pump, suitable for an installation in any room.



Compact tank pump

The SUNNY FLOWATCH® CLIM offers the best tank capacity/pump size of the market.



IPX4 protection

Protected against water splashes.



Removable integrated filter

Prevent dust and particles to damage the pump. Easy to remove and to clean.



Mounting brackets

Thanks to its mounting brackets (and screws and rawplugs supplied), pump can be easily fixed to the wall.



Inlet adapter included

This adapter allows condensate to enter the pump via tubes of different diameters.

FLOWRATE

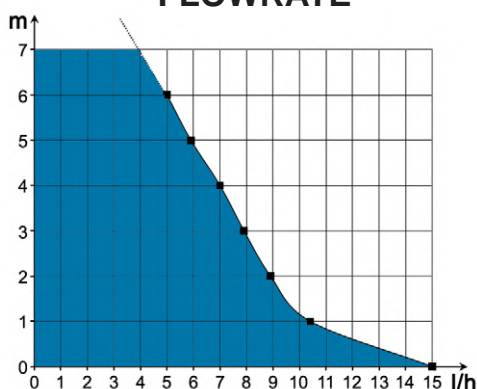

CONTENTS

Pump - Inlet tube - Screws and rawplugs

SUNNY FLOWWATCH® DUO

SICCOM

Mini tank pump (solenoid) for the condensate removal of gas condensing boilers up to 60kW / 200 000BTU.

Ref: DE05NCC090



PREMIUM

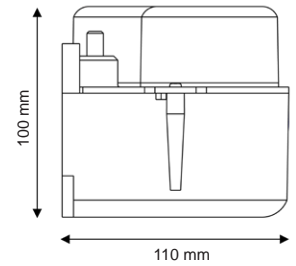
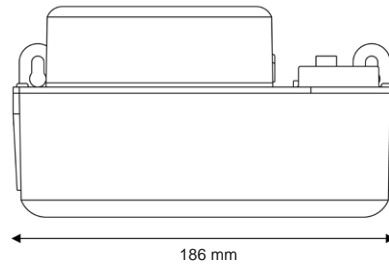

186 mm

100 mm

110 mm

Hose diameter
Discharge : 6/9 mm - not supplied

pH > 2.5



SPECIFICATIONS

Flowrate max	19 l/h
Discharge head max	10 m
pH tolerated	pH > 2.5
Electrical power	19W
Voltage	220-240V 50/60Hz
Alarm	NO-NC
Noise level	
Protection rating	IPX4
Thermal protection	Yes
Operating cycle**	100%
Power / alarm cable	1.5 / 1.3 m
Dimensions	186 x 110 x 100 mm
Certifications	CE, EAC

* The pump is able to run 100% of the time if necessary.

BENEFITS

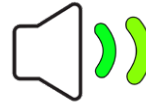

Very silent

Very silent pump, suitable for an installation in any room.



Compact tank pump

The SUNNY FLOWWATCH® DUO offers the best tank capacity/pump size of the market.



IPX4 protection

Protected against water splashes.



Removable integrated filter

Prevent dust and particles to damage the pump. Easy to remove and to clean.



Mounting brackets

Thanks to its mounting brackets (and screws and rawplugs supplied), pump can be easily fixed to the wall.



Inlet adapter included

This adapter allows condensate to enter the pump via tubes of different diameters.

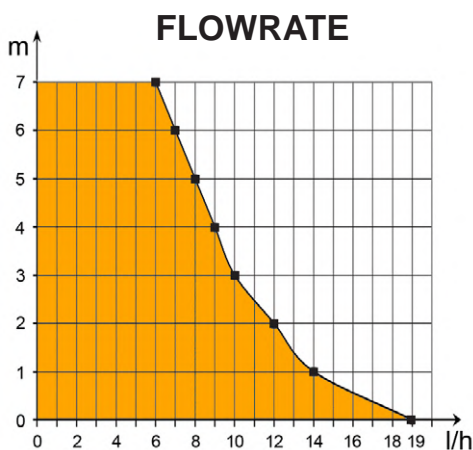

CONTENTS

Pump - Inlet tube - Screws and rawplugs

Centrifugal pump CP08

Universal centrifugal pump dedicated to split cassettes.

SICCOM

Ref: CP08SC6641



PREMIUM

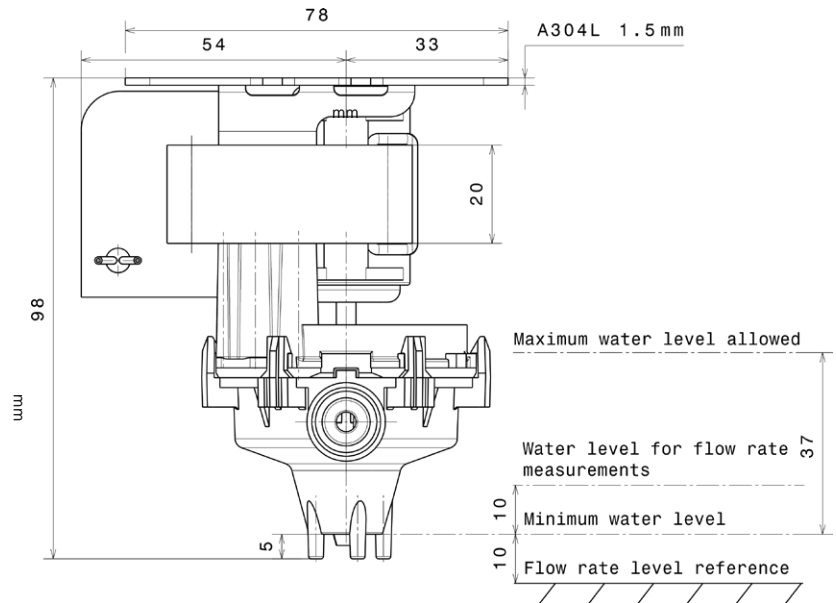

SPECIFICATIONS

Flowrate max	60 l/h
Discharge head max	110 cm
Electrical power	8W
Voltage	220-240V 50/60Hz
Noise level	
Protection rating	IP54
Temperature rise	66K
Operating cycle**	100%
Outlet tube	Ø 14 mm
Dimensions	87 x 75 x 98 mm
Certifications	CE, EAC

* The pump is able to run 100% of the time if necessary.

FLOWRATE

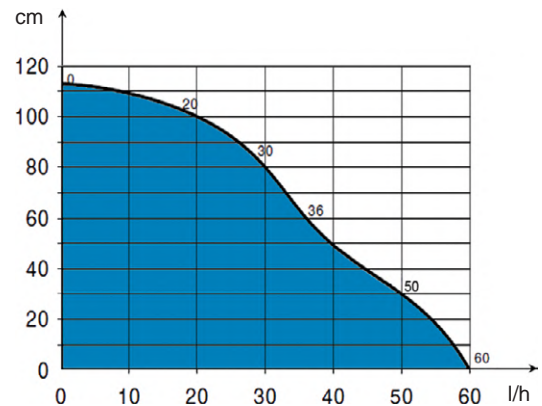

BENEFIT

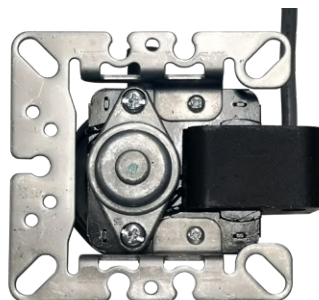

Universal plate

The CP08 mounting plate has been designed to fit the majority of cassette air conditioners on the market.

It can therefore easily replace another model of centrifugal pump at a cheaper price!

Pump accessories

Discover the range of accessories for SICCOM pumps, allowing easy installation and maintenance.



Connection extension kit
(extension cable 2m + suction tube 2m)
Ref: GC1KCTC710

This kit, coupled with a FLOWATCH® DESIGN, allows to move the pump in a false ceiling, and so:

- **REDUCE THE NOISE LEVEL**
- **FREED UP SPACE IN THE DUCT**

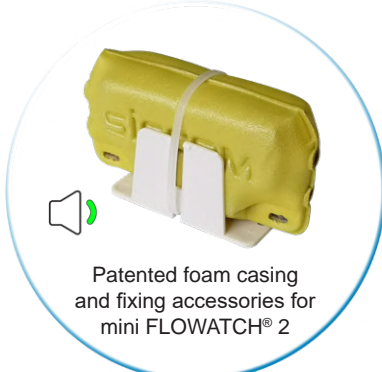
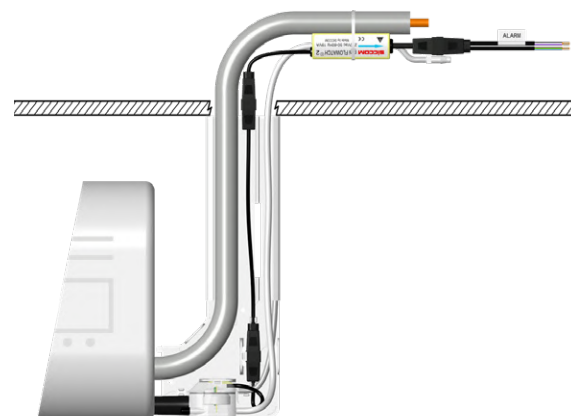

Patented foam casing and fixing accessories for mini FLOWATCH® 2

Kit COMFORT
Ref: GC077G1027

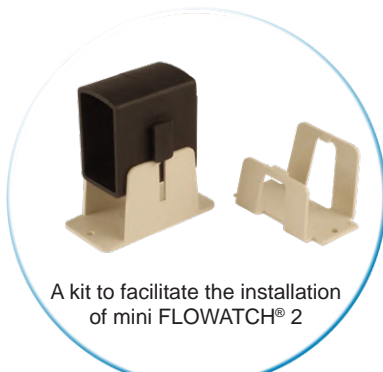

A kit to facilitate the installation of mini FLOWATCH® 2

Easy Fix
Ref: GC1KFX2010



The Stop Siphoning prevents the phenomenon of negative discharge on any installation.

Stop Siphoning
Ref: GC092A1001 (sachet de 10)
GC092A1002 (1 pièce)



Replacement reservoir for FLOWATCH® DESIGN

Short cable reservoir + air vent tube
Ref: GCDS3BTF4180



Replacement reservoir for mini FLOWATCH® 2

Long cable reservoir + air vent tube
Ref: GCDS3BTF4650

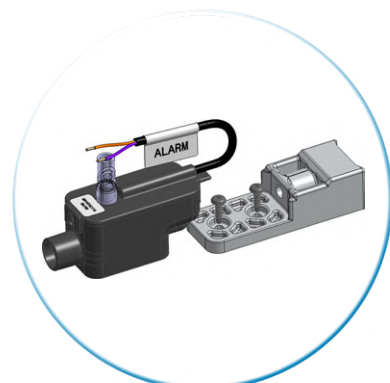

Alarm kit ECO pumps
Ref: DS1HTCC110



Bending tube Øint. 15mm
Ref: GC025D1017



Inlet adapter
FLOWATCH® TANK+
Ref: GC078H2008



Inlet adapter
SUNNY FLOWATCH®
Ref: GC078H2007

SICCOM also manufactures level and proximity sensors. Discover a part of our range below, and do not hesitate to contact us for further information.

Vertical sensors



DG series
Standard



DP series
Compact



DK series



DX series
Stainless steel



DY series
Detection by microswitches

Horizontal sensors



DHN series
Threaded fixing



DHG series
Seal compression fixing



DHM series
Nut fixing



DXN series
Stainless steel

Specific sensors



DC series
Multi-level resistive rod

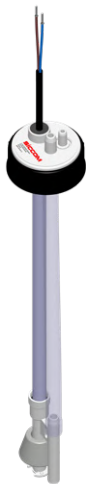

DB series
Suction cane with level detector



DD series
Resistive probe



DP series
Proximity sensors



OEM series
On-demand products



Find more informations on our website

Sensors for all your applications



and the medical, food, hydrocarbon, transportation, automotive industries...

CONDENSATE PUMPS

SICCOM is established all across the world.
As an international manufacturer, we are committed to product quality and reliability.

Listening, communication and service are the three key values for our customer approach.

We will be delighted to provide further information, so please
CONTACT US.



France

Tel: +33 6 83 82 46 02
Email: ychaves@siccom.fr

Italy, Switzerland & Central Europe

Tel/Fax: +39 02 96 36 21 40
Email: cconsales@siccom.fr

Spain & Latin America

Tel: +34 622 487 110
Email: tducasse@siccom.fr

Western Europe

Tel: +33 6 42 05 33 22
Email: pparadis@siccom.fr

SICCOM France - Headquarter International customer service

2, rue Gustave Madiot
ZI Les Bordes
91070 Bondoufle
Tel: +33 1 60 86 81 48
Email: commercial@siccom.fr

Northern & Eastern Europe

Tel: +33 6 83 82 46 00
Email: pgvassort@siccom.fr

Africa & Middle East

Tel: +33 6 42 05 33 22
Email: pparadis@siccom.fr

Northern America

Tel: +33 6 42 05 33 22
Email: pparadis@siccom.fr

India

Tel: +91 99 9900 3240
Email: djagga@siccom.fr

Asia

Tel: +33 6 43 31 19 27
Email: jlrendu@siccom.fr

Oceania

Tel: +33 6 83 82 46 00
Email: pgvassort@siccom.fr